

Enclosures **RJ Series**

Fiberglass Enclosure 6 x 6 x 6 Inches J Series Raised Cover with Hinged, Latched Opaque Cover



**Catalog
Number**

RJ606HPL

UPC

785928336904.0

List Price

\$239.89

DESCRIPTION

6H x 6W x 6D Inches J Series Fiberglass Enclosure with an "HPL" Raised Opaque Cover (Hinged, Padlock Latches) is designed for general electrical and electronic applications. Simple in its design, the enclosure can be configured with modifications such as cutouts and windows. Featuring a modest overhand cover on a flange mounted base, they offer unobstructed side-walls, built in mounting capabilities and a protective wrap around cover. J Series Products enhance any instrument installation.

APPLICATION

Industrial enclosure for harsh; aggressive environments

FEATURES

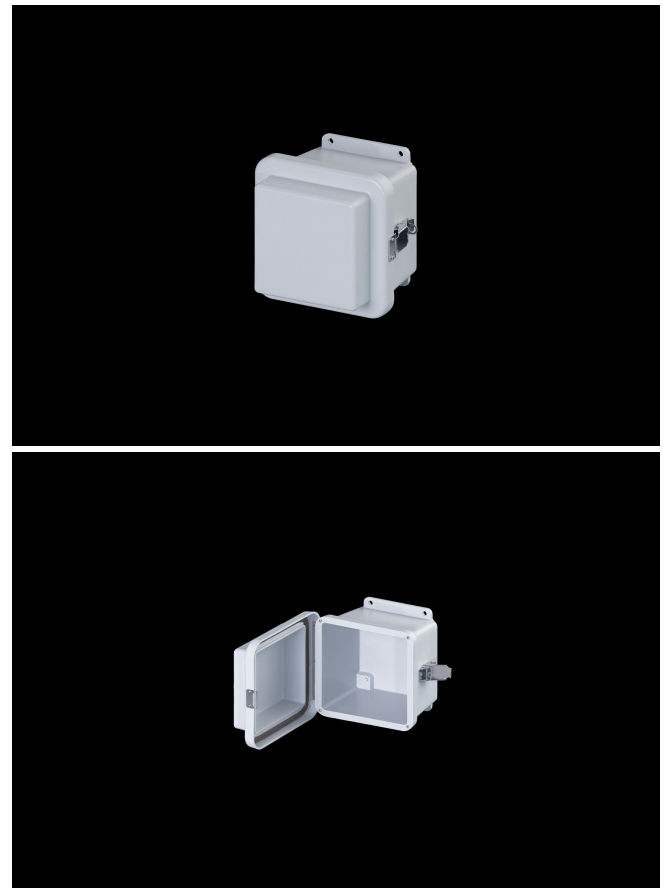

- Offers a "raised cover" that increases depth by adding to the depth of the cover.
- Increased wall thickness vs. competitive models offers structural support and prevents potential water ingress
- Integral mounting flange vs. mounting feet (no assembly required)
- Molded-in inserts provide added pull-out strength
- Raised Opaque Cover
- Overhang cover on smooth sided base
- High temperature; flame retardant; non-corrosive
- All stainless hardware latches and screws
- Full-length; stainless-steel hinge
- Chemically resistant; fiberglass reinforced polyester
- Non-corrosive; environmental designs
- Stainless steel retention chain on screw covers
- Continuous polyurethane gasket
- Manufactured with SolarGuard®, Stahlin's proprietary formulation of non-halogenated fiberglass, offering superior resistance to outdoor exposure, chemicals and flames.
- Back Panels Available for all sizes

General Information

Color	Gray
Cover Type	Opaque
Material	Fiberglass
Back Panel Screw Size	#10-32 x 3/8
Back Panel Recommended Torque	16-20 in-lbs
Back Panel Screw Material	304 SS
Installation Mounting Torque	45 in-lbs Max
Metal Inserts	Brass
Hinge Material	304 SS
Latch Material	304 SS
Gasket Material	Poured In Place (PIP) Polyurethane Seamless
Country of Origin	USA

DIMENSIONS

Height (in)	7.5
Width (in)	7.5
Depth (in)	6.3
Height (mm)	190.5
Width (mm)	191.3
Depth (mm)	160.5
Usable Depth (in)	5.5
Usable Depth (mm)	139.0

STANDARDS

NEMA 10250; UL 50; UL 50e; UL508A	cULus Listed File #E64358
CSA Std. C22.2	cULus Listed File #E64358
Type	1; 3R; 4; 4X; 6P; 12
IEC 60529; UL Listed #E362920	IP66
UL1741	UL Listed File #E333478
Plenum Space UL2043	Compliant
Temperature Range °F	-76°F to +274°F
Temperature Range °C	-60°C to +134°C
Flammability Rating	UL94-5VA
NFPA No. 101 Flame Spread	Class A(1)
Outdoor Exposure UL746c	(f1) Rated
CE	Certified